

MC 50 C

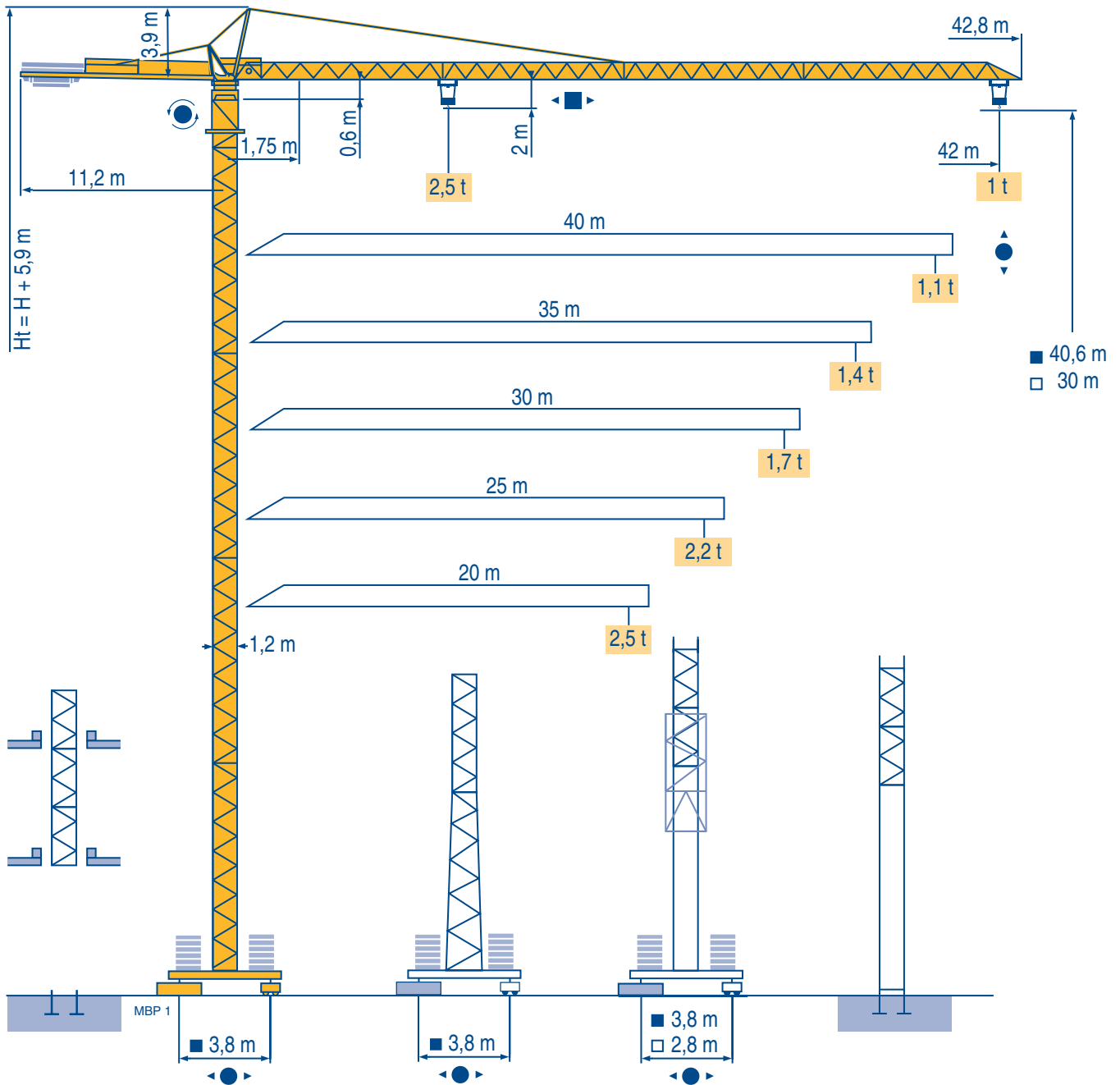

CITY CRANE

CE FEM 1.001-A3

Mat / Réactions \square 1,2 m
 Maste / Eckdrücke \blacktriangle
 Masts / Reactions 20 m \Rightarrow 42 m
 Mástil / Reacciones
 Torre / Reazioni
 Tramo / Reações

MBP 1

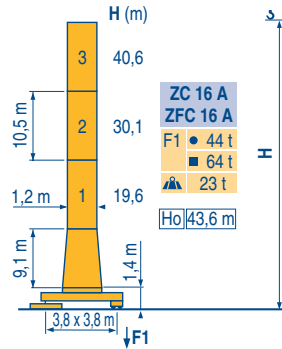
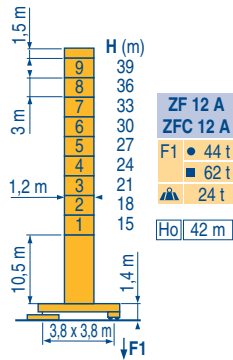
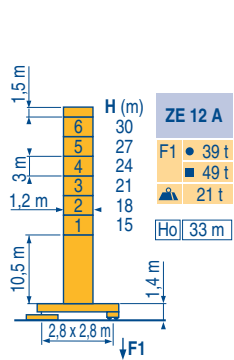
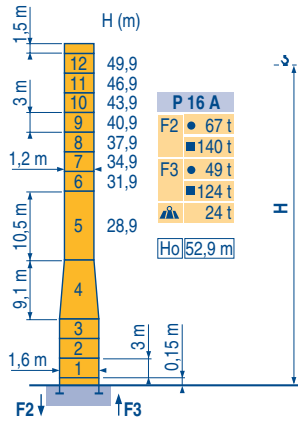
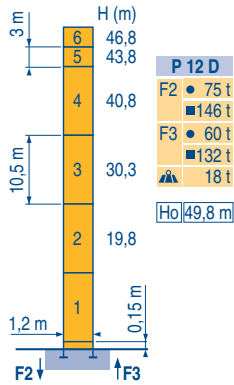
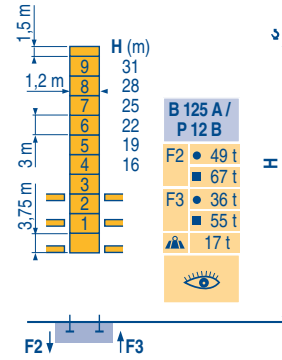
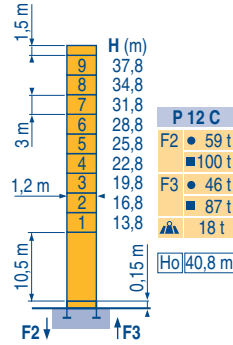
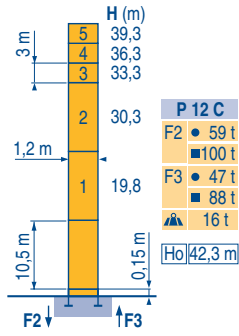

ZE - ZF - ZC - ZFC



CITY CRANE
 MC 50 C



F	D	GB	E	I	P
● Réactions en service ■ Réactions hors service ▲ A vide sans lest (ni train de transport) avec flèche et hauteur maximum.	● Reaktionskräfte in Betrieb ■ Reaktionskräfte außer Betrieb ▲ Ohne Last, Ballast (und Transportachse), mit Maximalausleger und Maximalhöhe.	● Reactions in service ■ Reactions out of service ▲ Without load, ballast (or transport axles), with maximum jib and maximum height.	● Reacciones en servicio ■ Reacciones fuera de servicio ▲ Sin carga, sin lastre, (ni train de transporte), flecha y altura máxima.	● Reazioni in servizio ■ Reazioni fuori servizio ▲ A vuoto, senza zavorra (ne assali di trasporto) con braccio massimo e altezza massima.	● Reações em serviço ■ Reações fora de serviço ▲ Sem carga (nem trem de transporte)- sem lastro com lança e altura máximas.
Ho H sans cabine	Ho H Ohne Fahrerhaus	Ho H without cab	Ho H sin cabina	Ho H senza cabina	Ho H sem cabine

Courbes de charges
Lastkurven
Load diagrams
Curvas de cargas
Curve di carico
Curva de cargas

MBP 1

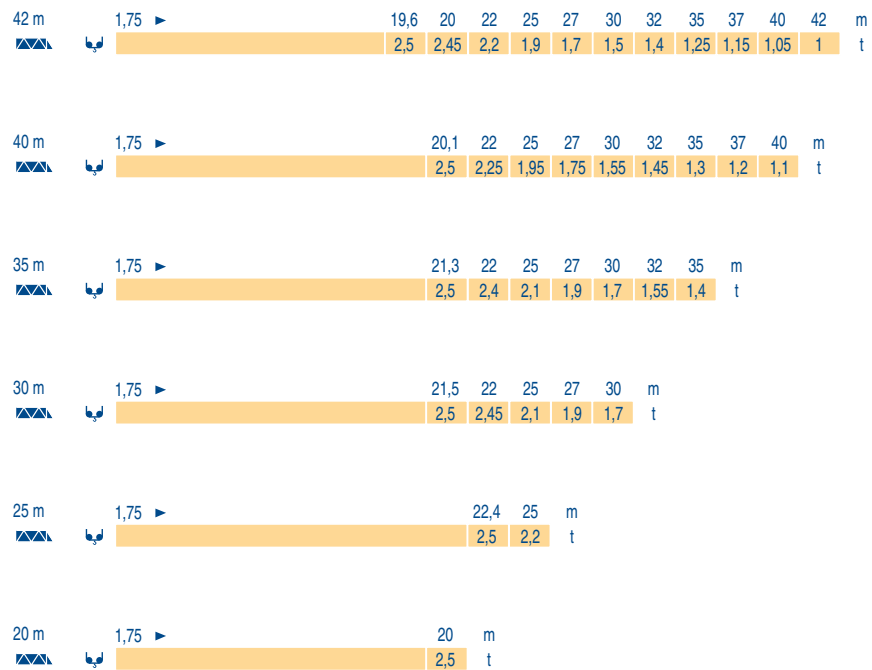

Télescopage sur dalles
Kletterkrane im Gebäude
Climbing crane
Telescopage gruas trepadoras
Gru in cavedio
Telescopagem sobre lages

MBP 1

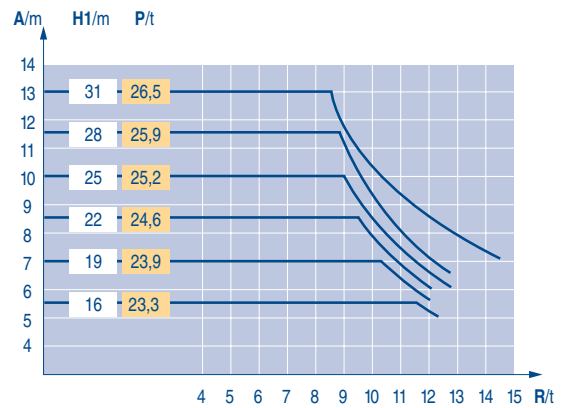
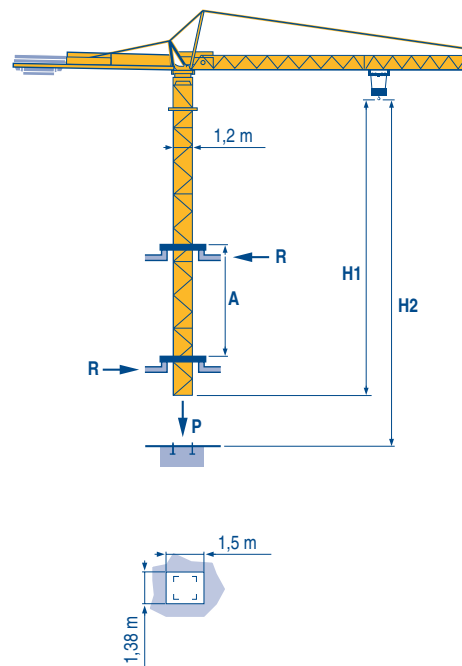

B 125 A

CITY CRANE
MC 50 C



	F	D	GB	E	I	P
A	Distance entre cadres	Abstand zwischen den Rahmen	Distance between collars	Distancia entra marcos	Distanza fra i telai	Distância entre quadros
H1	Hauteur grue	Kranhöhe	Crane height	Altura grúa	Altezza gru	Altura da grua
P	Poids de la grue(en service)	Krangewicht (in Betrieb)	Crane weight (in service)	Peso de la grúa (en servicio)	Peso della gru (in servizio)	Peso da grua (em serviço)
R	Réaction horizontale	Horizontalkräfte	Horizontal reaction	Reaccion horizontal	Reazione orizzontale	Reacção horizontal
	Voir télescopage sur dalles	Siehe Kletterkrane im Gebäude	See climbing crane	Vea grua trepadora	Consultare gru in cavedio	Ver telescopagem sobre lages

Mécanismes
Antriebe
Mechanisms
Mecanismos
Meccanismi
Mecanismos

MBP 2

					ch - PS hp	kW			
	15 PC 13 AC-1	m/min	7,1	21	42	15	11	130 m	
		t	2,5	2,5	1,3				
	25 PC 13 AC-1	m/min	7,9	31,5	63	25	18		
		t	2,5	2,5	1,3				
20 LVF 13	m/min	5 →	31 →	57 →	20	15	230 m		
	t	2,5	2,5	1,3				0,65	
	3 D2 V5	m/min	21 - 42			3	2,2		
	RCV 40	tr/min U/min rpm	0 → 0,8			6	4,5		
	ZE - ZF 	TVD 324	m/min	26			2 x 4	2 x 2,9	
	ZC - ZFC 	RT 224	m/min	25			2 x 4	2 x 2,9	
CEI 38		IEC 38		kVA					
400 V (+6% -10%) 50 Hz		15 PC : 25 kVA 25 PC : 35 kVA 20 LVF : 30 kVA		2000/14					

	F	D	GB	E	I	P
	Levage	Heben	Hoisting	Elevación	Sollevamento	Elevação
	Distribution	Katzfahren	Trolleying	Distribución	Distribuzione	Distribuição
	Orientation	Schwenken	Slewing	Orientación	Rotazione	Rotação
	Translation	Kranfahren	Travelling	Traslación	Traslazione	Tranlação
	Conforme aux directives CEE sur le niveau acoustique	Gemäss EWG-Richtlinien für den Schall-Leistungspegel	In compliance with the EEC Instructions on noise level	Conforme con las directivas CEE sobre el nivel acustico	Conforme alle direttive CEE sul livello acustico	Conforme as directivas CEE sobre o nível acústico

Document commercial non contractuel. Pour toute information technique se référer à la notice correspondante

Unverbindliches Vertriebsdokument. Für technische Informationen, siehe die entsprechenden Anweisungen.

This commercial document is not legally binding. For any technical information, please refer to the corresponding instructions.

Documento comercial no contractual. Para cualquier información técnica, ver la noticia correspondiente.

Documento commerciale non vincolante, per tutte le informazioni tecniche fare riferimento al catalogo istruzioni

Documento comercial não contratual. Para qualquer informação técnica complementar consultar as respectivas instruções

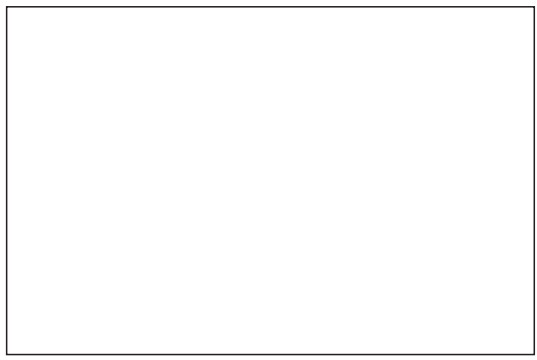

Americas
Tel: +1 920 683 6322
Tel: +1 717 597 8121

Europe - Middle East - Africa
Tel: +(33) 4 72 81 50 00
Tel: +(44) 191 565 6281

Asia - Pacific
Tel: +(65) 6861 7133
Fax: +(65) 6862 4142

www.manitowoccrane.com

**18, rue de Charbonnières - B.P.173
69132 ECULLY Cedex - France**

Tél. : (33) 4 72 18 20 20
Fax. : (33) 4 72 18 20 00
www.manitowoccrane.com www.potain.com

CITY CRANE MC 50 C
Réf. 2004 42 MBP 2

Copyright.Reproduction interdite © POTAIN 2004

Réalisation Sedoc